

Ref. Des.	80M	40M
C1	100 pF	47 pF
C2	330 pF	220 pF
L1	22 uH	10 uH
L2	4.7 uH	2.2 uH

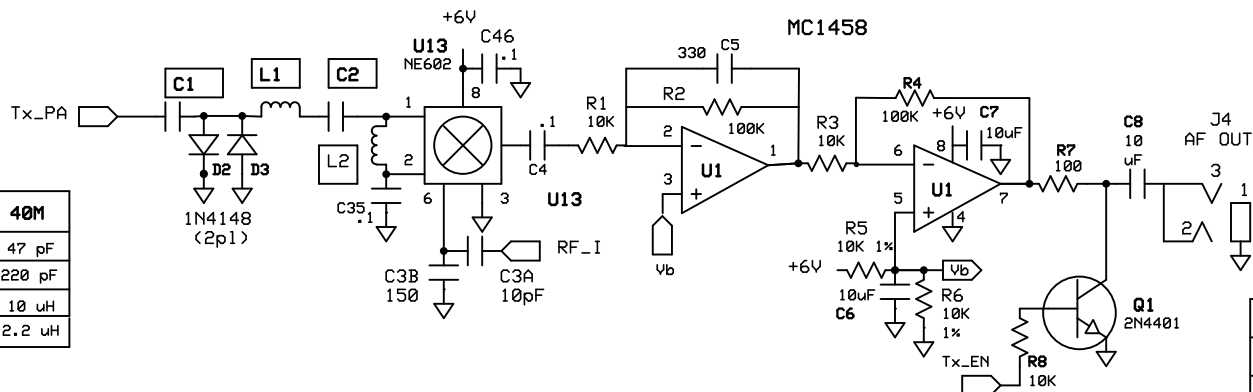

Ref. Des.	80M	40M
C18	680 pF	330 pF
C22	680 pF	330 pF
C23	1500 pF	820 pF
C24	820 pF	470 pF
C25	180 pF	100 pF
L3	3.3 uH	1.5 uH
L5	20 turns on T50-2	14 turns on T50-2
L6	24 turns on T50-2	16 turns on T50-2

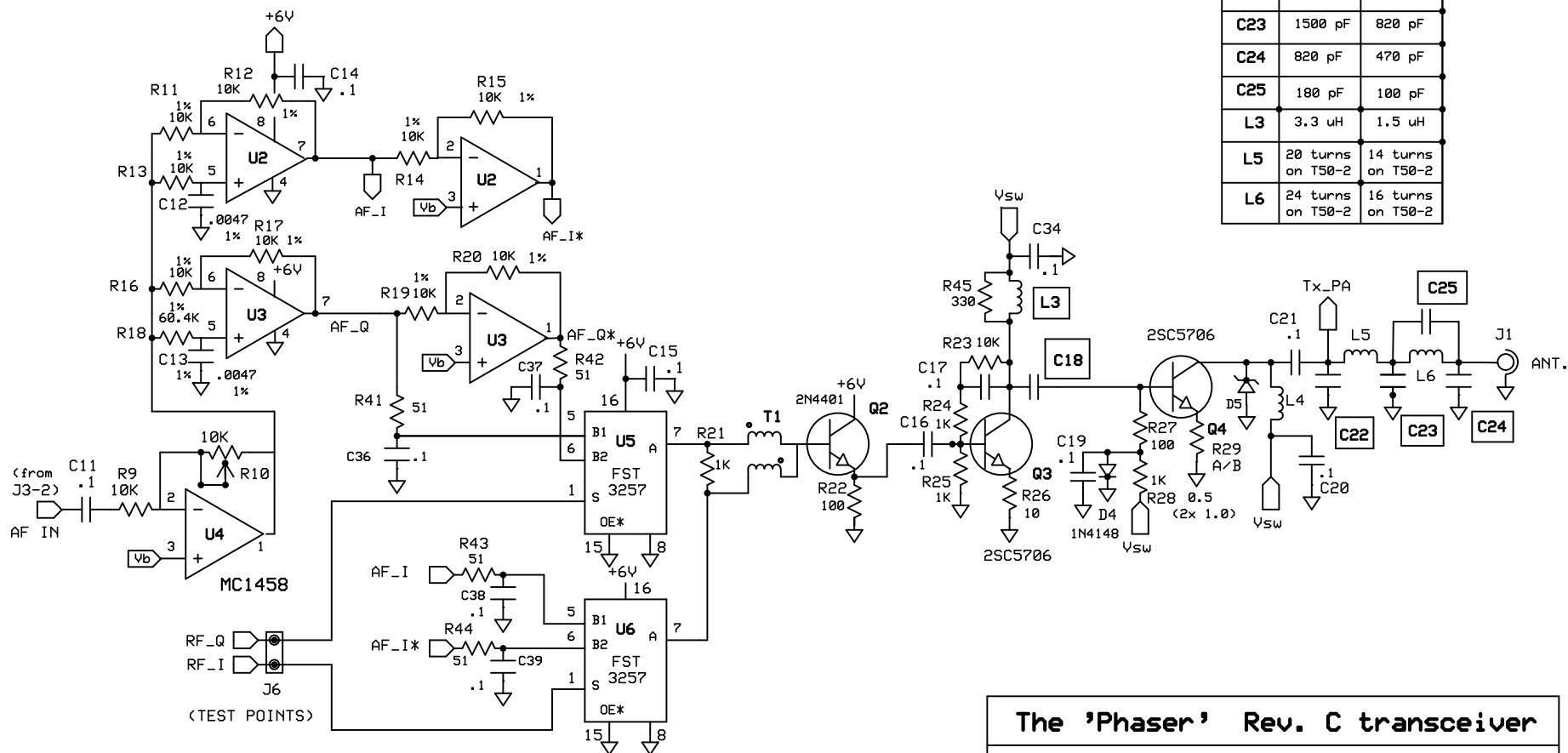

The 'Phaser' Rev. C transceiver

Transmitter/receiver Schematic 80M/40M